

Series TIH™

Fluoropolymer In-Line Chemical Heater

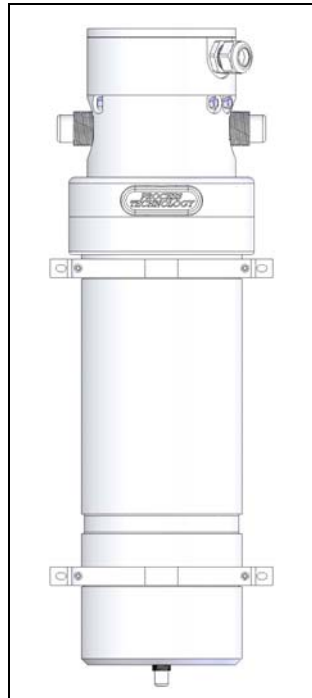

Installation Manual

Please supply your in-line heater model and serial number when ordering spare parts or when requesting technical assistance.



Your Distributor:





80 Metcalfe Street • Buffalo, NY 14206 U.S.A. • US/CN: 800-777-2436 • 716-856-2300 • Fax: 716-856-7115
www.cdibuffalo.com • E-mail: sales@cdibuffalo.com

Table Of Contents:

INTRODUCTION	2
CHEMICAL COMPATABILITY	5
PERFORMANCE DATA	6
SYSTEM SPECIFICATIONS	8
MODEL NUMBER	9
FACILITY REQUIREMENTS	14
SPACE REQUIREMENTS	14
ELECTRICAL REQUIREMENTS	14
LIQUID PLUMBING REQUIREMENTS	15
PURGE GAS REQUIREMENTS	15
INSTALLATION	16
SYSTEM REQUIREMENTS	16
UNCRATING AND INSPECTION	17
COMPONENT IDENTIFICATION	17
MOUNTING HEATER	18
FLUID CONNECTIONS	19
PURGE GAS CONNECTIONS	24
ELECTRICAL CONNECTIONS	26
SUPPORTING EQUIPMENT	30
SAFETY FEATURES	31
SAFETY LABEL LOCATIONS	31
SAFETY SYSTEM NETWORK	32
OPERATION	35
START UP	35
CLEANING	35
SHUT-DOWN	36
DRAINING	36
MAINTENANCE	37
PREVENTATIVE MAINTENANCE OF THE IN-LINE HEATER CHAMBER	37
SERVICE	38
WARRANTY	39

INTRODUCTION:

The following symbols and warning labels may appear on the unit and in the instruction manual. The table below provides an explanation of each one.

DESCRIPTION	PICTORIAL DESCRIPTION
WARNING indicates a potentially hazardous situation which, if not avoided, could result in death or serious injury.	
CAUTION indicates a potentially hazardous situation which, if not avoided, may result in minor or moderate injury. It may also be used to alert against unsafe practices.	
CAUTION: ELECTRICAL SHOCK HAZARD Voltage or current hazard sufficient to cause shock, burn or death. Disconnect and lock out electrical power before servicing.	
CAUTION: HOT SURFACE. DO NOT TOUCH Heater chamber may be hot. Allow unit to cool before servicing.	

INTRODUCTION (CONTINUED):

Process Technology TIH in-line heaters are designed to maintain the process fluid while also providing safe, energy-efficient heating. The low mass-to-wattage ratio of the patented heating elements yields optimum response; the unit heats quickly and the elements will not retain latent heat, a potential cause for overshoot. The wetted surfaces of the heater and chamber are constructed of high purity fluorocarbon polymers.

The TIH in-line heater can operate at a variety of temperature and pressure conditions. Reference Chart 1, TIH Pressure vs. Temperature for the maximum vessel pressure at a given operating temperature.

TIH Vessel Rating

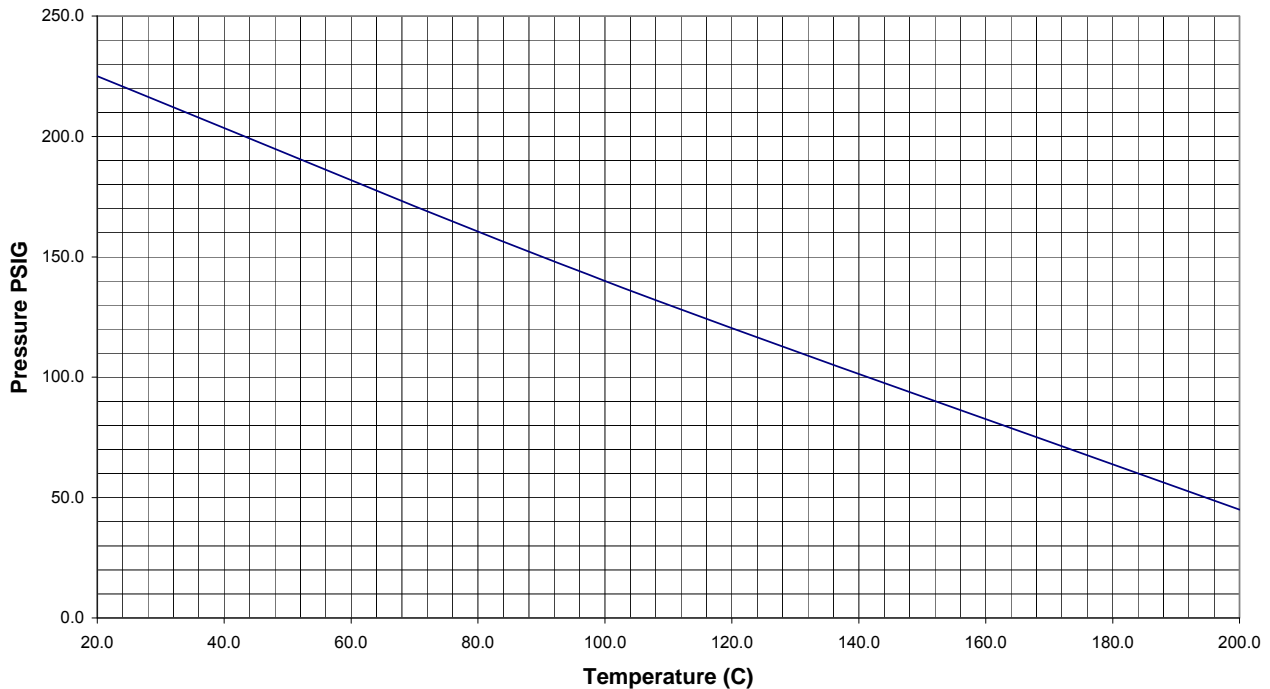

Chart 1: Maximum Chamber Pressure vs. Operating Temperature



Safe operation of this heater requires the use of over-temperature control sensors with an approved safety switching device. Operating in excess of the maximum operating temperature (180°C) can result in conditions that can cause harm to operators and equipment.

INTRODUCTION (CONTINUED):

The Standard Process Technology TIH Series In-Line Heater consists of:

- * *PTFE Fluoropolymer heavy-wall chamber*
- * *Purged PTFE covered resistive heating element*
- * *3 meters (10ft) FEP Fluoropolymer covered power cable*
- * *3 meters (10ft) FEP covered sensor cable*
- * *Process sensor; RTD1000 standard*
- * *Heating element over-temperature sensor; RTD1000 standard*
- * *Thermal cut-off device (TCO), one-time use eutectic fuse, set at 240°C*
- * *19mm (3/4") PFA Flared inlet and outlet plumbing connections*
- * *12mm (1/2") PFA Flared drain connection*
- * *Corzan (CPVC) mounting brackets*

Optional Equipment may include:

- * *"J" or "K" type thermocouple or 100-Ohm RTD process temperature sensors*
- * *"E" or "K" type thermocouple or 100-Ohm RTD element over-temperature sensors*
- * *Additional "J", "E", or "K" type thermocouple, RTD100 or RTD1000 process over-temperature sensors*
- * *Custom lengths of Power and Signal cables*
- * *Different sizes and types of plumbing connections*
- * *Different plumbing layout configurations*
- * *Different sizes and type of drain connection, or no drain connection*
- * *Purge gas flow and back pressure controls*
- * *PVDF mounting brackets*

If the Chamber Heater is purchased as part of a system, the following equipment may be included. These items are required for safe operation, and must be customer-supplied, if not purchased with the heater.

- * *Process temperature controller*
- * *Liquid level sensor*
- * *Purge Flow pressure regulator and flowmeter*
- * *Proper high-voltage power fusing and electrical disconnect switch*
- * *Drain valve (if the unit is equipped with an optional drain)*
- * *Pump motor safety interlock circuit*

INTRODUCTION (CONTINUED):

CHEMICAL COMPATABILITY:

Although fluoropolymer is resistant to most chemicals, there are some process chemistries with which the in-line heater should not be used. These include the following:

- Chemicals that degrade or decompose when heated.
- Chemicals that are flammable, explosive, or produce dangerous or irritating vapors when heated.
- Halogenated solvents which attack the fluoropolymer material.

 CAUTION	Do not use the TIH in line heater to heat incompatible chemistries. Incompatible materials will cause corrosion of the heating elements, process sensor, junction box or flange cover. TIH heater failure will result
--	--

 CAUTION	This Model Process Technology Fluoropolymer In-Line Heater heats process fluid to temperatures as high as 180°C. However, the over-temperature protection circuit will allow the heating elements to reach temperatures as high as 300°C. Consult the factory BEFORE attempting to heat flammable or combustible fluids.
--	---

INTRODUCTION (CONTINUED):

Performance Data:

The TIH series in-line heaters are designed to be used in either single pass or multi-pass (recirculating) flow applications. An application is defined as single pass when the solution will enter the heating chamber only once and must be heated to the desired temperature when it exits the heater. A multi-pass application is one in which the solution will be recirculated through the process and returned to the chamber heater, and may take several cycles through the heater to reach the desired temperature.

Single Pass Flow Application:

For single pass applications, the TIH heater is designed to provide a specified temperature increase at a given flow rate. Tables 1 shows the maximum temperature increase (ΔT) that can be achieved for continuous flow conditions at heater powers from 1-18 kW.

Flow LPM	Heater Power, kilowatts (kW)										Flow GPM
	1	2	3	4.5	6	9	10	12	13.5	18	
0.95	15	30	48	68	91	-	-	-	-	-	0.25
1.9	-	15	23	34	45	68	76	91	102	-	0.5
2.8	-	10	15	23	30	45	51	61	68	92	0.75
3.8	-	-	11	17	23	34	38	45	51	68	1
4.7	-	-	9	14	18	27	30	36	41	55	1.25
5.7	-	-	-	11	15	23	25	30	34	45	1.5
6.6	-	-	-	10	13	19	22	26	29	39	1.75
7.6	-	-	-	9	11	17	19	23	25	34	2
8.5	-	-	-	-	10	15	17	20	22	30	2.25
9.5	-	-	-	-	9	14	15	18	20	27	2.5
10.4	-	-	-	-	-	12	14	17	18	25	2.75
11.4	-	-	-	-	-	11	13	15	17	23	3
12.3	-	-	-	-	-	10	12	14	15	21	3.25
13.2	-	-	-	-	-	10	11	13	14	19	3.5
14.2	-	-	-	-	-	9	10	12	13	18	3.75
15.1	-	-	-	-	-	9	9	11	12	17	4

Table 1: Maximum Temperature Increase as a function of power vs. flow

INTRODUCTION (CONTINUED):

Multi-Pass Flow Application:

For a multi-pass application, the TIH heater will elevate and maintain the temperature of a fixed volume of solution as it is circulated. Use the following formula to estimate the heat-up time for a volume of fluid in a multi-pass system. For estimating purposes, the specific heat and weight of water are often used. However, more accurate results will be achieved using the properties of the specific solution.

$$\text{Heat-up Time (min.)} = \frac{\text{Volume (Liters, l)} \times \text{Volumetric Mass (kg/L)} \times \text{Temp. Increase (K } (^\circ\text{C)})}{\text{Heater Power (kW)} \times 60,000} \times \text{Specific Heat (J/(kgK))}$$

This formula does not take into account any heat losses to the surrounding environment. The typical heat loss from the PTFE chamber is approximately 210 Watts. Other factors that must be considered include heat losses through plumbing and exposed process tank surfaces, and the load placed on the heater by the introduction of cold products and chemicals into process tanks.

SYSTEM SPECIFICATIONS:

Product	TIH series inline chemical heater
Standards (TIH)	CE, UL 499 Certified, Semi S2
Available Wattages	1 - 18 kW Refer to model number label for the wattage of a specific unit
Available Voltages	120 VAC – 600 VAC, 50/60Hz, single or three phase
Dimensions:	Refer to facilities print for specific heater dimensions
Wetted surfaces:	
Heating elements	PTFE fluoropolymer
Chamber	PTFE fluoropolymer
o-rings	PFA encapsulated Viton, PFA encapsulated silicon
Operating temperatures:	
Process inlet	Up to process outlet temperature
Process outlet	Up to 180°C, depending upon operating conditions
Ambient air temperature	-30°C to 60°C
Chemical flow rate range	1 l/min (0.25 gpm) to 14 l/min (3.7 gpm)
Chemical pressure range at 25°C	Minimum 69 kPa (0.69 bar, 10 psi) Maximum 1500 kPa (15 bar, 225 psi)
Chemical pressure range at 180 C	Minimum 69 kPa (0.69 bar, 10 psi) Maximum 400 kPa (4 bar, 60 psi)
Purge gas flow rate:	28 - 56 l/hr (1-2 scfh)
Purge gas pressure:	Maximum 138 kPa (1.38 bar, 20 psi)
Standard Mounting Brackets	CPVC Rated up to 115°C (239°F)
Hi Temp Mounting Brackets	PVDF Rated up to 135°C (275°F)

MODEL NUMBER:

Process Technology model numbers are designed to offer some description of the heater construction, including features and options. The model number can be found on the model/serial number label located on the junction box located on the top of the TIH Series Heater.

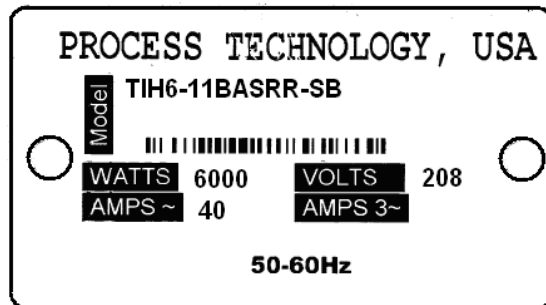

Figure 1: Model Number Label



Figure 2: Serial Number Label

Model Number Explanation:

Provided below is an example of a typical model number along with an explanation of each part. This key will help you understand your model number.

Model number example:

TIH
6
-
1
1
B
A
S
R
R
-
SB

①
②
③
④
⑤
⑥
⑦
⑧
⑨
⑩

- ① **Heater Series Type.** The model number will always begin with the series type of your heater.
- ② **Heater Wattage.** The first Numbers in the model number will always be the wattage of your heater. The table provided below identifies the standard available wattage ratings of the Series TIH Heater.

HEATER MODEL NUMBER	HEATER WATTAGE (W)
1	1,000
2	2,000
3	3,000
4.5	4,500
6	6,000
9	9,000
12	12,000
13.5	13,500
18	18,000

- ③ **Heater Voltage.** The next set of up to (2) characters following the heater Wattage will describe the rated Voltage of the heater.

Heater Model Number	Rated Voltage (V)	Heater Model Number	Rated Voltage (V)
1	208	7	440
2	240	8	575
3	380	9	220
4	400	10	200
5	415	12	120
6	480	14	600

Model Number Explanation (continued):

TIH
6
-
1
1
B
A
S
R
R
-
SB

①
②
③
④
⑤
⑥
⑦
⑧
⑨
⑩

- ④ **Voltage Supply Phase.** This character indicates if the required voltage supply is to be single phase or 3 phase.

Heater Model Number	Required Phase
1	Single phase
3	Three phase

- ⑤ **Process Inlet/Outlet Plumbing Connections.** The characters used to describe the plumbing connections signify the type of connection and its size. The heater inlet and outlet plumbing connections are the same type and size. Please refer to the table below to see the specific plumbing connections provided with the heater:

Heater Model Number	Plumbing Connection Type	Plumbing Connection Size: mm (in)
A	Flared tube fitting	12mm (1/2-inch)
B	Flared tube fitting	19mm (3/4-inch)
C	Flared tube fitting	25mm (1-inch)
S	Flared tube fitting	9mm (3/8-inch)
T	Super 300 type Pillar tube fitting	9mm (3/8-inch)
V	Super 300 type Pillar tube fitting	12mm (1/2-inch)
W	Super 300 type Pillar tube fitting	19mm (3/4-inch)
X	Super 300 type Pillar tube fitting	25mm (1-inch)

- ⑥ **Process Drain Plumbing Connections.** The heater drain connection follows the same character code for connection type and size. Please refer to the table below to see the specific plumbing connections provided with the heater:

Heater Model Number	Drain Connection Type	Drain Connection Size: mm (in)
O	No Drain Fitting	N/A
A	Flared tube fitting	12mm (1/2-inch)
B	Flared tube fitting	19mm (3/4-inch)
S	Flared tube fitting	9mm (3/8-inch)
T	Super 300 type Pillar tube fitting	9mm (3/8-inch)
V	Super 300 type Pillar tube fitting	12mm (1/2-inch)
W	Super 300 type Pillar tube fitting	19mm (3/4-inch)
Y	Super 300 type Pillar tube fitting	6mm (1/4-inch)
Z	Flared tube fitting	6mm (1/4-inch)

Model Number Explanation (continued):

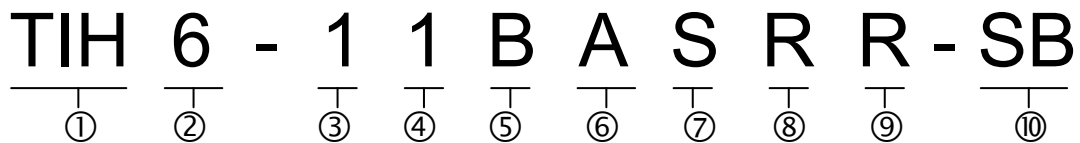

- ⑦ **Plumbing Configuration.** There are several plumbing configuration options available with the Process Technology Series TIH inline heater. Please refer to the table below for a brief listing of the available options.

Heater Model Number	Description
S	Straight (180 degrees inlet, outlet, center bottom drain)
R	Bottom side inlet, rotated 90° to right of outlet (center bottom drain)
L	Bottom side inlet, rotated 90° to left of outlet (center bottom drain)
A	Bottom side inlet, directly below outlet (center bottom drain)
B	Bottom center inlet (center of bottom, no drain)
C	Straight (bottom side drain below inlet)
D	Straight (bottom side drain below outlet)

- ⑧ **Process Sensor Type.** Several process sensor types are available for the Process Technology Series TIH Heater. Please refer to the table below for a brief listing of the available options.

Heater Model Number	Process Sensor Description
J	Type "J" Thermocouple
K	Type "K" Thermocouple
R	1000 ohm RTD, 2-wire
H	100 ohm RTD, 3-wire

- ⑨ **Element Over-temperature Sensor Type.** Several element over-temperature sensor types are available for the Process Technology Series TIH Heater. Please refer to the table below for a brief listing of the available options.

Heater Model Number	Process Sensor Description
E	Type "E" Thermocouple
K	Type "K" Thermocouple
R	1000 ohm RTD, 2-wire
H	100 ohm RTD, 2-wire

Model Number Explanation (continued):

TIH
6
-
1
1
B
A
S
R
R
-
SB

①
②
③
④
⑤
⑥
⑦
⑧
⑨
⑩

⑩ **Options.** Additional options available with the TIH heater are listed at the end of the model number. Please refer to the table below for a brief listing of the available options.

Heater Model Number	Description
Blank	No Additional Options
X##	Longer Cord Length (in Inches)
SB	PVDF mounting brackets
BR	No mounting brackets
CR	Cord sets rotated 90° to right of outlet
CL	Cord sets rotated 90° to left of outlet
C8	Cord sets rotated 180° from outlet
D	De-rated (below standard watt density)
L	128°C TCO setting (240°C standard)
##	Custom design (Typically a 2-digit number)

FACILITY REQUIREMENTS:

Before installing the TIH in-line chemical heater confirm the facility requirements listed below. Facility requirements for a specific model are provided separately, in a TIH facilities print. Refer to this facilities print for specific requirements for your TIH heater.

Space Requirements:

TIH in-line heaters are designed to be installed within the tool or bench near the process tank assembly. Allow adequate space in the tool for mounting of the heater. Also provide space to make necessary power and plumbing connections to the heater.

	<p>The heater should be installed in an area free from excessive chemical or liquid exposure. The electrical junction area must not be submerged or exposed to excessive splashing or high pressure spray to prevent corrosion of internal components. Air temperatures surrounding this heater must not exceed 60°C. Do not install or operate this heater in explosive or combustible environments.</p>
---	---

Electrical Requirements:

Separate cables are provided for heater power and the various safety sensors. Reference the heater's model number tag for the electrical power requirements of this heater. Fuse ratings noted in this document are for reference only. Verify that the electrical service is rated and fused for the required amperage draw.

Ensure electrical facilities meet local jurisdictional requirements before operating this unit. This will include the following components:

- Electrical disconnect devices
- Over-current protection (circuit breakers or fusing)
- Isolation and switching devices
- High voltage wiring

	<p>Do not exceed the rated voltage. Irreparable damage to the heater will result.</p>
---	---

FACILITY REQUIREMENTS (CONTINUED):

Liquid Plumbing Requirements:

The Series TIH in-line heater plumbing connections include fluid inlet and outlet connections, as well as a drain connection (unless otherwise specified).

Plumbing must be compatible with process chemicals and temperatures.

This product is intended to be installed in an open system. The outlet plumbing should be connected directly to an open tank. Ensure there are no valves or devices intended to restrict flow between the heater outlet and the open tank. Over-pressure protection should be installed to prevent pressures in excess of the maximum pressure at a specific temperature. Refer to Chart 1 for maximum pressure versus temperature information.



Do not exceed maximum temperature/pressure rating of this unit. Irreparable damage to the heater will result.

Purge Gas Requirements:

A source of purge gas, nitrogen (N₂) or clean dry air (CDA) is required for the heater element purge system. This TIH in-line heater uses 6 mm (1/4-in) compression fittings as the purge gas inlet and outlet connections.

The purge gas supply must be regulated to a Maximum 138 kPa (1.38 bar, 20 psi) gas pressure. With a flow rate of 28-56 l/hr (1-2 scfh).



Do not exceed pure gas pressure of 1.38 bar (20 PSI). Irreparable damage to the heating element may result.

INSTALLATION:

Before installation, carefully read this entire section.

System Requirements:

Location: This heater is designed to be located in areas where exposure to process chemistry is likely. The heater is constructed of materials resistant to the process chemistry, but is not designed to be externally submerged.

	<p>The heater must be located in an area where ambient temperature is maintained between –30 to 60°C.</p> <p>Over-pressure protection should be installed to prevent pressures in excess of the maximum pressure at a specific temperature. Reference Chart 1 in <i>Introduction</i> for additional information.</p> <p>Do not install or operate this heater in explosive or combustible atmospheres.</p>
---	---

Space: The chamber is designed to be mounted vertically using the supplied mounting brackets.

Process Fluid Connections: The liquid connections provided are the inlet and outlet connections. Most units also include a drain fitting. Follow appropriate instruction for your specific type and size of plumbing connections.

Electrical Connections: The electrical connections are provided as two separate “cables”. These two cables are the POWER CABLE and the SIGNAL CABLE. Check the heater system tag for power requirements. Verify that the incoming power line is rated and fused for the required amperage draw.

Purge Gas Connections: The standard purge gas inlet and outlet connections are 6 mm (1/4-in) compression fittings, located above the fluid outlet.

INSTALLATION (CONTINUED):

Uncrating and Inspection:

- 1) Inspect the shipping crate for evidence of damage. If any damage is detected, contact the carrier immediately.
- 2) Remove the Heater assembly from its shipping container.



Support the heater cables during heater unpacking and installation. Failure to support the cables may result in heater damage.

- 3) Remove box containing all support equipment.
- 4) Remove any protective packaging material and discard.
- 5) Inspect unit for any apparent physical damage. If any damage is detected, contact the carrier immediately.
- 6) Check packing list for all parts.

Component Identification:

Refer to supplied drawing.

Includes the following items:

- 1) Heater Chamber Assembly: Consists of patented, purged PTFE resistive heating elements enclosed in a PTFE Fluoropolymer chamber.
- 2) Process Fluid Connections: Refer to your facilities print or the MODEL NUMBER section of this manual for a description of the process fluid connections included with your specific unit.
- 3) Mounting Brackets: For heating chamber. Two brackets are standard for 1kW through 12 kW models. 3 brackets are standard for the 13.5kW models and 18kW models.

INSTALLATION (CONTINUED):

Mounting Heater:

Reference the provided facility drawing for the quantity, location and dimensions of the mounting brackets.

Location: Process Technology TIH in-line heaters are designed to be installed within the tool or bench near the process tank assembly. The compact design uses a minimum amount of space.

Expected Sources of Danger: The heater should be installed in an area free from excessive chemical or liquid exposure. The electrical junction area must not be submerged or exposed to excessive splashing or high pressure spray. Refer to the *System Specifications* table for temperature limitations.

 CAUTION	Excessive chemical exposure may cause corrosion of the Corzan (CPVC) electrical box and flange covers, or customer supplied mounting hardware. Loss of heater support or corrosion of the electrical wiring may result, causing damage to the heater.
--	---

Mounting chamber assembly: The TIH in-line heater chamber assembly requires vertical mounting to a physically capable structure. Mounting brackets are supplied.

- 1) Ensure that the chamber is mounted vertically with the outlet connection at the top.

 CAUTION	Support the heater cables during heater unpacking and installation. Failure to support the cables may result in heater damage.
--	--

- 2) Securely bolt chamber assembly in the desired location.

 CAUTION	Do not over-torque the mounting hardware to the mounting brackets. Physical damage to the mounting brackets will result, causing loss of heater support.
--	--

Mounting the optional Process Control and Flow Control Module: Mount the Back Pressure Enclosure in a properly vented area. Note that the gas exiting the purge outlet will carry some amount of process chemical vapor. Refer to dimensional drawings included with the Control Modules for actual cut-out dimensions required for panel mounting of any included control modules.

INSTALLATION (CONTINUED):

Plumbing Connections:

The TIH heater is intended to be installed in an open system. The outlet pipe/tubing should be plumbed directly to an open tank. Ensure there are no valves or devices intended to restrict flow between the heater outlet and the open tank.

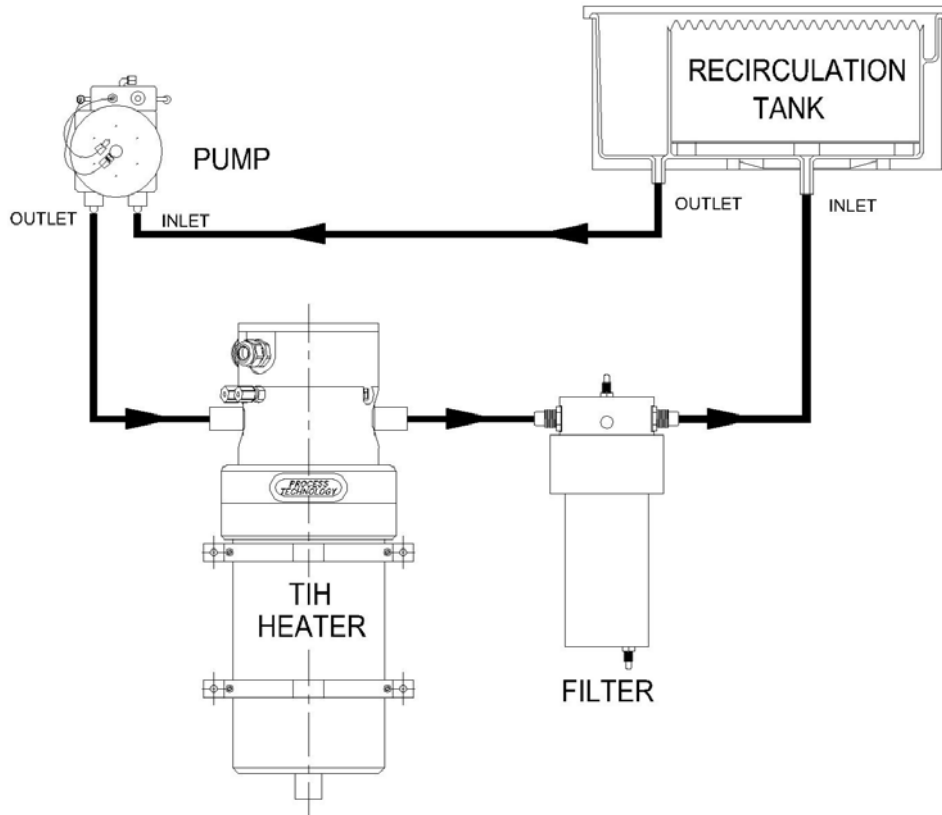

Figure 3: Closed loop (circulation) plumbing layout

The TIH in line heater is available with either flared tube fittings, or Super 300 type Pillar fittings, in various sizes. Please follow the appropriate plumbing procedure for the connections provided with your unit. Refer to the MODEL NUMBER section of this manual to help identify the plumbing connection type and size provided with your unit.

INSTALLATION (CONTINUED):

Flared tube inlet/outlet plumbing connections:

- 1) Remove the protective plastic caps from the Flared fittings on the Inlet and Outlet piping of the heater assembly.
- 2) Connect properly flared tubing to the Inlet and Outlet of the heater chamber assembly.
- 3) Tighten the fitting nuts until fitting nut contacts the flared tubing. Tighten an additional ¼ turn. Then torque, fitting nut to the minimum required torque value. See **Table 2** for proper values.

Table 2:

Fitting Size	Torque Value
12mm (½-in) Flared	1.24 Newton-meter (11in-lbs).
19mm (¾-in) Flared	1.58 Newton-meter (14in-lbs).
25mm (1-in) Flared	3.39 Newton-meter (30in-lbs).



Ensure Process Fluid Line connections are at 30°C or below before tightening of the fittings. Tightening the fitting at higher temperatures will result in damage to the tubing, and to the liquid seal.

Flared tube drain connection:

The drain connection must be plumbed to an appropriate zero pressure drain, which must be compatible with the process chemistry and temperature.



The drain should be plumbed to an appropriate facility chemical drain. Any material released from this outlet will contain process fluid. Plumbing must be compatible with process chemicals and temperatures!

1. Remove the protective plastic caps from the Flared Compression fitting on the drain fitting.
2. Connect appropriately sized tubing to the drain fitting.
3. Tighten the fitting nut until it contacts the flared tubing. Tighten an additional ¼ turn.
4. Then torque the fitting nut to the minimum required torque value. See **Table 2** for proper values.



Ensure Process Fluid Line connections are at 30°C or below before tightening of the fittings. Tightening the fitting at higher temperatures WILL result in damage to the flared tubing, and damage to the seal.

INSTALLATION (CONTINUED):

Super 300 Type Pillar™ inlet/outlet plumbing connections:

Optional Super 300 Type Pillar™ process fluid line connections use a “gauge ring” (see figure), which is used to determine the proper tightness of the fitting connections. Check the facilities print for the connections supplied with this unit.

- 1) Remove the protective plastic caps from the Pillar fittings on the Inlet and Outlet piping of the heater assembly.
- 2) Install appropriately sized Super 300 Type Pillar “gauge ring”.

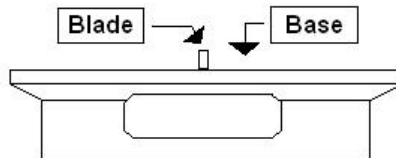

Figure 4: Super 300 Type Pillar gauge ring

- 3) Connect properly sleeved tubing to the Inlet and Outlet of the heater chamber assembly.
- 4) Tighten the Pillar fitting nut until the bosses on the union nut makes contact with the gauge ring and pulls the blade. A crunching sound will be heard at this point. Continue tightening the union nut until the bosses make full contact with the gauge ring.

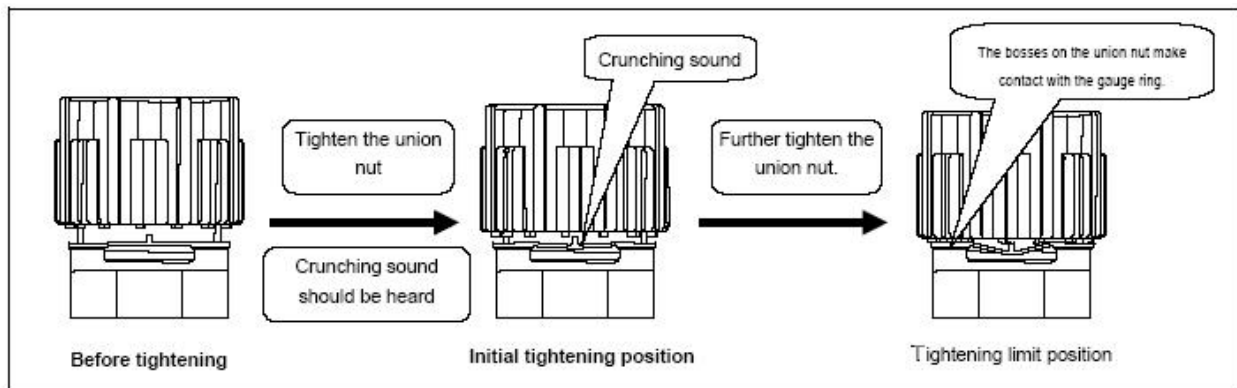

Figure 5: Super 300 Type Pillar connection procedure

INSTALLATION (CONTINUED):

Super 300 Type Pillar™ Process Fluid Drain Connections:

The drain connection must be plumbed to an appropriate zero pressure drain, which must be compatible with the process chemistry and temperature.



The drain should be plumbed to an appropriate facility chemical drain. Any material released from this outlet will contain process fluid. Plumbing must be compatible with process chemicals and temperatures!

- 1) Remove the protective plastic caps from the compression fitting.
- 2) Install appropriately sized Super 300 Type Pillar “gauge ring”.
- 3) Connect properly sleeved tubing to the drain connection of the heater chamber assembly.
- 4) Tighten the Pillar fitting nut until the bosses on the union nut makes contact with the gauge ring and pulls the blade. A crunching sound will be heard at this point. Continue tightening the union nut until the bosses make full contact with the gauge ring.

INSTALLATION (CONTINUED):

Drain Connections for units without drain fittings:

The installation of an in-line heater that was not supplied with a drain requires a source of low pressure Nitrogen or CDA (maximum 10 psig (69 kPa) regulated to a flow rate of 5scfh (140 l/h) and additional hardware to allow draining of fluid from the chamber. The following schematic shows the required hardware and configuration.

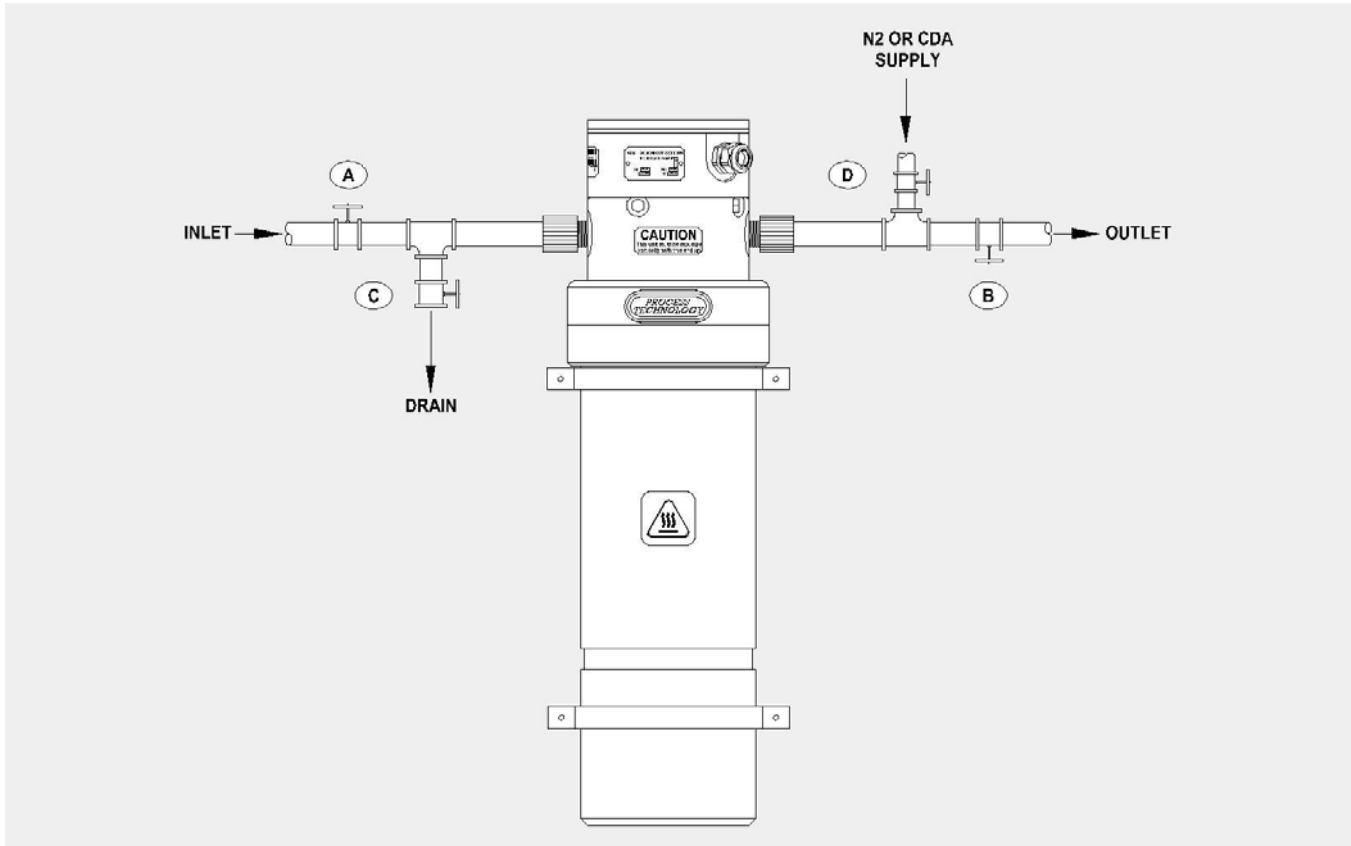



Figure 6: Alternate method for draining the TIH without a built in drain fitting

INSTALLATION (CONTINUED):

Purge Gas Connections (without TIHF purge control):

The TIH in-line heater requires a purge gas during operation. The purge gas to the chamber must be regulated to a flow rate of 1-2 scfh (28-56 lph) at a maximum pressure of 138 kPa (20psig).

	Do not exceed pure gas pressure of 1.38 bar (20 PSI). Irreparable damage to the heating element may result.
---	--

The purge gas connections are located above the outlet fitting. The standard connections are 6 mm (1/4-in) compression fittings.

	Under normal conditions, exhaust gas will consist of only the purge gas; however, there is a potential for chemical fumes and/or liquid to be exhausted if a failure occurs in the heater element. The exhaust gas should be properly vented as chemical exhaust.
---	--

- 1) Using 6 mm (1/4-in) OD tubing, connect the purge INLET to a pressure regulator connected to the purge gas supply. Hand tighten the fitting cap until seated. Tighten an additional 1/4 turn.
- 2) Using 6 mm (1/4-in) OD tubing, connect the Heater Purge Exhaust (labeled OUTLET) to an approved exhaust area. Hand tighten the fitting cap until seated. Tighten an additional 1/4 turn.

	Do not over-tighten the fitting cap. Over-tightening the cap will result in damage to the fitting and/or tubing.
---	---

INSTALLATION (CONTINUED):

Purge Gas Connections (with TIHF purge control):

A system which includes a purge control will be able regulate the correct purge gas pressure to the heater purge line. Thus, the purge gas supply needs only to be regulated from 20-100 psig (138-690kPa) inlet pressure.

The purge gas connections are located at the top of the heater chamber. The standard connection is a 6mm (¼) compression fitting. Check the facilities print for your heater model for the connection type supplied with this unit.



Under normal conditions, exhaust gas will consist of only the purge gas; however, there is a potential for chemical fumes and/or liquid to be exhausted if a failure occurs in the heater element. The exhaust gas should be properly vented as chemical exhaust.

Connections for unit with (optional) Flow Control Module:

- 1) Using 6mm (¼-in) OD tubing, connect the purge INLET to Purge Gas supply (or Flow Panel outlet).
- 2) Using 6mm (¼-in) OD tubing, connect the purge OUTLET to the Back Pressure Enclosure INLET (may be located at rear of optional Flow Panel Enclosure).
- 3) Using 6mm (¼-in) OD tubing, connect the Back Pressure Enclosure EXHAUST to an approved exhaust area.

INSTALLATION (CONTINUED):

Electrical Connections:

The TIH in-line heater has separate power and sensor cable connections.

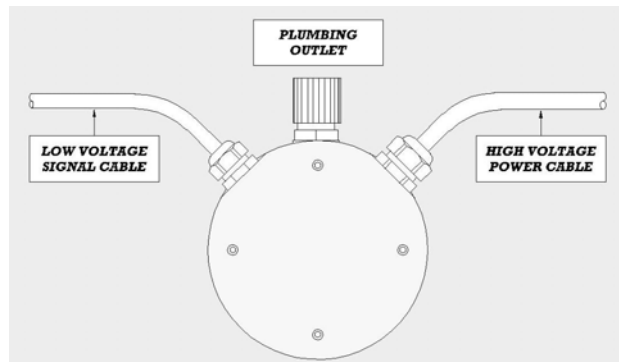

Figure 7: TIH Electrical Cables

Power Cable:

The POWER CABLE consists of two or three black power leads, and (1) one green ground lead.

- 1) Refer to the model number label for the power requirements for this heater.
- 2) Fuse the incoming power supply lines for the rated amperage using an approved electrical disconnect. The electrical disconnect must meet the following minimum requirements:
 - Appropriate voltage and amperage ratings for the specific heating system. Verify that all fused electrical disconnects meet jurisdictional requirements.
 - For safety of service and maintenance personnel, this electrical disconnect must be located within sight of the equipment.
- 3) Ensure that all services are off before making connections (electrical, liquids, and gas). Lockout and Tagout as appropriate. Use only approved and properly rated wire, conduit and connectors.

CAUTION

Support the heater cables during heater unpacking and installation. Failure to support the cables may result in heater damage.

- 4) Connect heater leads to an electrical disconnect device in the customer supplied controller. This electrical disconnect must have the proper electrical rating necessary for the equipment. Tighten wire connections to appropriate torque setting, indicated on the electrical component.

CAUTION

An improperly torqued wire connection may overheat during operation, resulting in melted wires and heater damage.

- 5) Connect heater ground wire to proper electrical earth ground.
- 6) Check all connections before applying power.

INSTALLATION (CONTINUED):

Electrical Connections:

Signal Cable:

The standard Series TIH in-line heater is supplied with independent temperature control and over-temperature protection devices. These sensors may be RTD sensors (100 or 1000 ohm) or thermocouples (J, K or E type), depending upon the model number. Refer to the MODEL NUMBER section of this manual to confirm the type of sensors provided. The sensor wires are numbered at the factory. Please refer to your TIH electrical schematic for the corresponding wire numbers on your unit.

Note: Failure to use the supplied sensors and TCO devices for their intended purposes may void all or part of the equipment warranty. Consult factory for technical assistance.

The SIGNAL CABLE on the standard heater consists of the following:

- Process temperature sensors
 - Thermocouples; two each, same type.
 - RTDs; three each, same type.
- Heater over-temperature sensors (two each, same type).
- Thermal cutoff (TCO) device (one each, one orange wire and one yellow wire leads)

Refer to the tables below for sensor wire details.

Process Sensor Example: TIH6-11BASRR-SB

TIH Model: Process Sensor	Sensor Description	Component Label	Component Lead Wire Color	Sensor Cable Wire Number/Color
R	3 each, 1000-Ohm 2-wire RTD	1RTD	White	Red
			Red	Orange
		2RTD	Black	Violet
			Green	Blue
		3RTD	Violet	Grey
			Yellow	Red-Blue
H	3 each, 100-Ohm 3-wire RTD	1RTD	Green	Orange
			Black	Red
			Black	Violet
		2RTD	Yellow	Blue
			Purple	Grey
			Purple	Red-Blue
		3RTD	White	Black
			White	White-Black
			Red	Pink
			Red	Green-Yellow
J	2 each, J-type thermocouple	1TC	White	White
			Red	Red
		2TC	White	White-Black
			Red	Red-Black
K	2 each, K-type thermocouple	1TC	Yellow	Yellow
			Red	Red
			Yellow	Yellow-White
		2TC	Red	Red-White

INSTALLATION (CONTINUED):

Electrical Connections:

Signal Cable (Continued):

Over-temperature Sensor Example: TIH6-11BASRR-SB

TIH Model: Over-temperature Sensor	Sensor Description	Component Label	Component Lead Wire Color	Sensor Cable Wire Color
R	2 each, 1000-Ohm 2-wire RTD	4RTD	White	Green
			Red	Tan
		5RTD	White	Brown
			Red	Orange-Black
H	2 each, 100-Ohm 2-wire RTD	4RTD	White	Green
			Red	Tan
		5RTD	White	Brown
			Red	Orange-Black
E	2 each, E-type thermocouple	3TC	Violet	Violet
			Red	Red
		4TC	Violet	Violet-White
			Red	Red-White
K	2 each, K-type thermocouple	1TC	Yellow	Yellow, or Yellow-Black
			Red	Red, or Red-Black
		2TC	Yellow	Yellow-White, or Yellow-Green
			Red	Red-White, or Red-Green
	1 each TCO, eutectic fuse	TCO	Orange	Yellow
			Orange	Orange, or White

Process temperature sensor(s):

The Process Temperature Sensor measures the temperature of the process fluid at the outlet of the heater chamber. The sensor is intended to be used as the primary control input for the process temperature controller. Additional sensors (optional) are for use as backup or in auxiliary safety circuits.

	<p>It is recommended that this sensor be used as the primary input for process control. However, in the event an external sensor is used to control the heater, the internal Process temperature sensor <u>must</u> be used to prevent over-heating of the process fluid!</p> <p>If the Process temperature sensor is used to prevent over-heating of the process fluid, ensure that the corresponding controller is set to disable power to the heater at a maximum of 10°C above the process control setpoint.</p>
---	--

INSTALLATION (CONTINUED):

Heater over-temperature sensor(s):

The customer supplied Heater over-temperature control device must be connected to this sensor. It measures the operating temperature of the heating element.

	<p>This sensor <u>must be</u> connected to an ELV (extra low voltage circuit(s)). This sensor MUST be connected to an approved safety switching device. Activation of the over-temperature protection should require manual reset to enable heating. This sensor is in direct physical contact with the metallic heating element sheath and consequently in contact with protective earth/ground.</p>
---	---

Heater element TCO (thermal cutoff device):

The heater element TCO is a eutectic fuse that will open when it reaches a preset temperature. This is a single use device intended to protect adjacent equipment in the event of a heater failure. Activation of the TCO is usually associated with irreparable damage to the heating element. Replacement of the TCO requires removal of the heater chamber and return to the manufacturer. Inspection of the heating element will determine if element replacement is also required and/or possible. Contact the Technical Service Department for assistance.

The TCO should be connected to interrupt the operation of the control circuit if it opens.

	<p>Do not connect the TCO in series with the heating element/main load. The TCO is designed to be wired into the heater's control circuit, connected in series with the coil of the magnetic contactor for the main load.</p>
---	--

INSTALLATION (CONTINUED):

Supporting Equipment

Liquid level sensor:



The use of a process fluid level sensor is required. Heater operation must be interrupted if the heating element is not completely immersed in liquid. Detection of liquid cannot be measured inside the heating chamber.

The Series TIH in-line heater is to be used with a Liquid level sensor. The In-line heater can be used with a capacitance-type Liquid level sensor connected to the outlet tube of the heater. The sensor monitors the presence of solution in the outlet piping to ensure that the heating coil remains immersed in process solution during operation.

The Liquid level sensor must be wired into the heater control circuitry in such a manner, as to shut the heater off when there is no liquid in the outlet tube of the heater.

If using the Process Technology supplied SLC-4-DR Liquid Level Sensor, connect as follows:

- 1) Locate the sensor extension cable and plug it into the control module.

Note: If using the SBC-J or TIHC-J membrane-style control module, plug the sensor extension cable into the receptacle of the single channel electronic control module.

- 2) Mount the tube adapter on the outlet plumbing as close as possible to the supplied outlet fitting.
- 3) Remove protective sensor probe tip cap. Carefully install the desired probe tip into adapter.

Note: Full installation/calibration procedures for the SLC-4-DR Liquid Level Sensor are located in the installation manual included with the SLC-4-DR sensor.

INSTALLATION (CONTINUED):

Purge Control Module Connections (Optional):

The Series TIH In-line heater assembly can be supplied with a TIHF purge control module. The flow control module monitors internal nitrogen purge pressure of the PTFE covered heating element.

	<p>If a Flow Control Module is supplied with the In-Line Heater, the it must be connected into the heater safety circuitry.</p>
---	---

- 1) Locate the supplied Purge Control Interconnect cable and connect the 4 pin AMP plug into its mating receptacle on the face of the Flow Control Module.
- 2) Wire the other half of the supplied interconnect cable into the heater control circuitry of the customer supplied process controller.

SAFETY FEATURES:

1.1 SAFETY LABEL LOCATIONS:

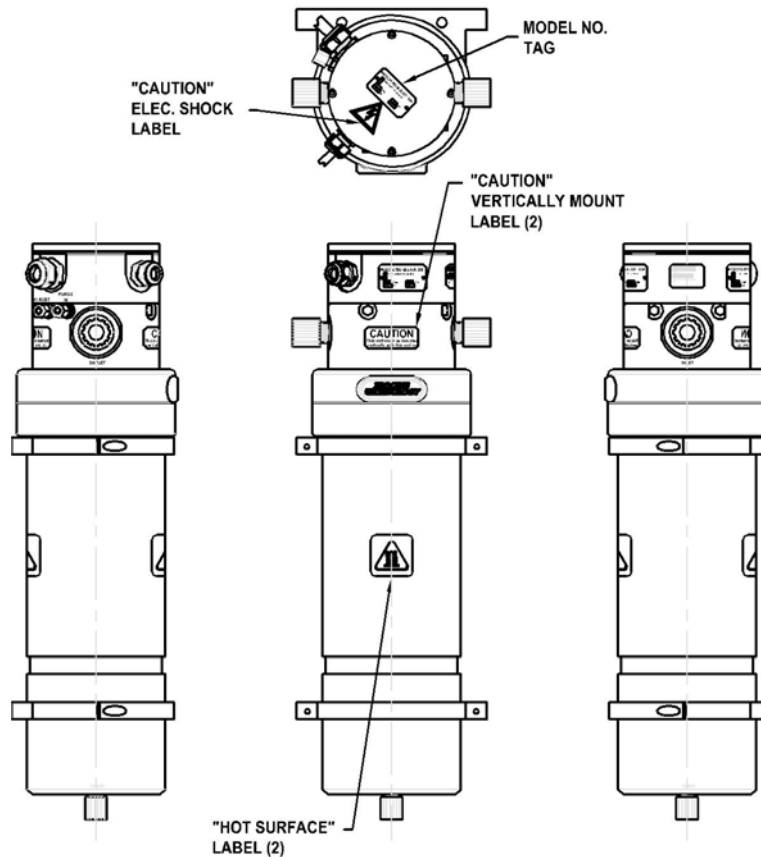

Figure 8: Safety Label Locations

SAFETY FEATURES (CONTINUED)

Safety System Network:

This TIH in-line heater is supplied without a temperature control package. Certain safety interlocks must be incorporated into the control package to prevent damage to the heater and ensure the safety of the operator. Each interlock circuit monitors a critical operating parameter of the heater. The control system is designed so that if a "fault condition" is detected by any one of the sensors, the power to the heating element is disengaged. The shutdown mechanism may be momentary or latching; refer to table below.

Safety device	Operation	type of shutdown
Pump Interlock	Monitors condition of pump, disrupts power to heater when pump is not in operation.	Latching, requires manual reset
Liquid Level Control	Monitors presence of adequate fluid in heater vessel, disrupts power to heater if fluid is not present in the outlet piping.	Latching, requires manual reset
Process Temperature Control Device	Monitors temperature of fluid in heater chamber, disrupts power to heater when temperature rises above setpoint.	momentary
Process Over-Temperature Control Device	Monitors temperature of fluid in heater chamber, disrupts power to heater when temperature rises above setpoint.	momentary
Heater Over-Temperature Safety Device	Monitors temperature of heating element, disrupts power to heater when temperature rises above setpoint. (Refer to chart 2).	Latching, requires manual reset
Heater Element TCO	Monitors temperature of heating element, disrupts power to heater when temperature rises above melt point of TCO.	Permanent. Contact factory for heater repair or replacement unit

SAFETY FEATURES (CONTINUED):

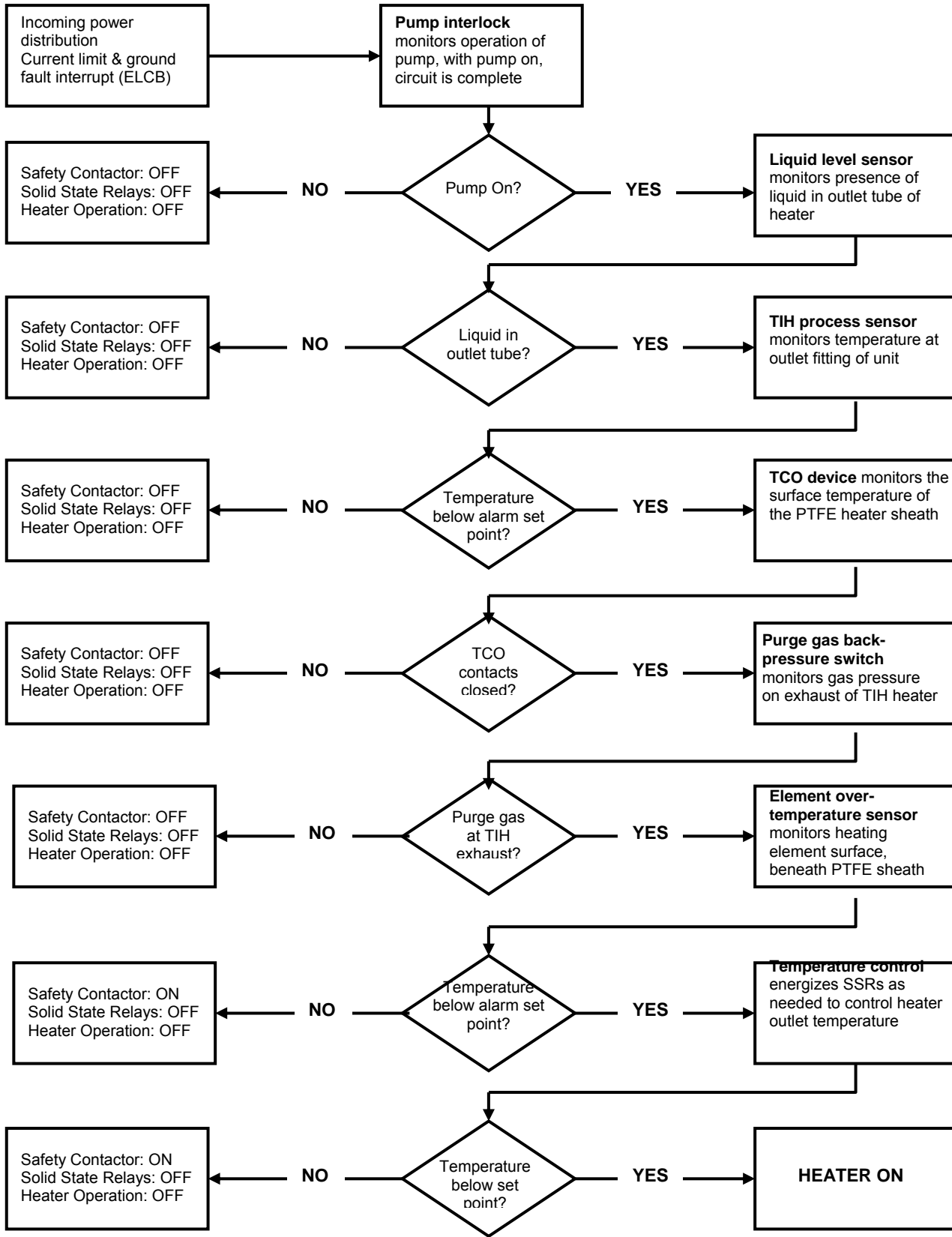

Figure 9: Safety circuit flow chart

SAFETY FEATURES (CONTINUED):

Over-temperature Control Device:

The TIH in-line heater's PTFE covered element operates at a higher temperature than the process solution. The element over-temperature control device measures the temperature of the heating element and will interrupt the power to the heater if excessive element temperature is detected.

Set the element over-temperature control using the graph below. The graph shows the maximum normal element temperature with respect to the process temperature (setpoint). Set the over-temperature control to the temperature that corresponds to the process setpoint temperature.

Overtemperature Settings for TIH

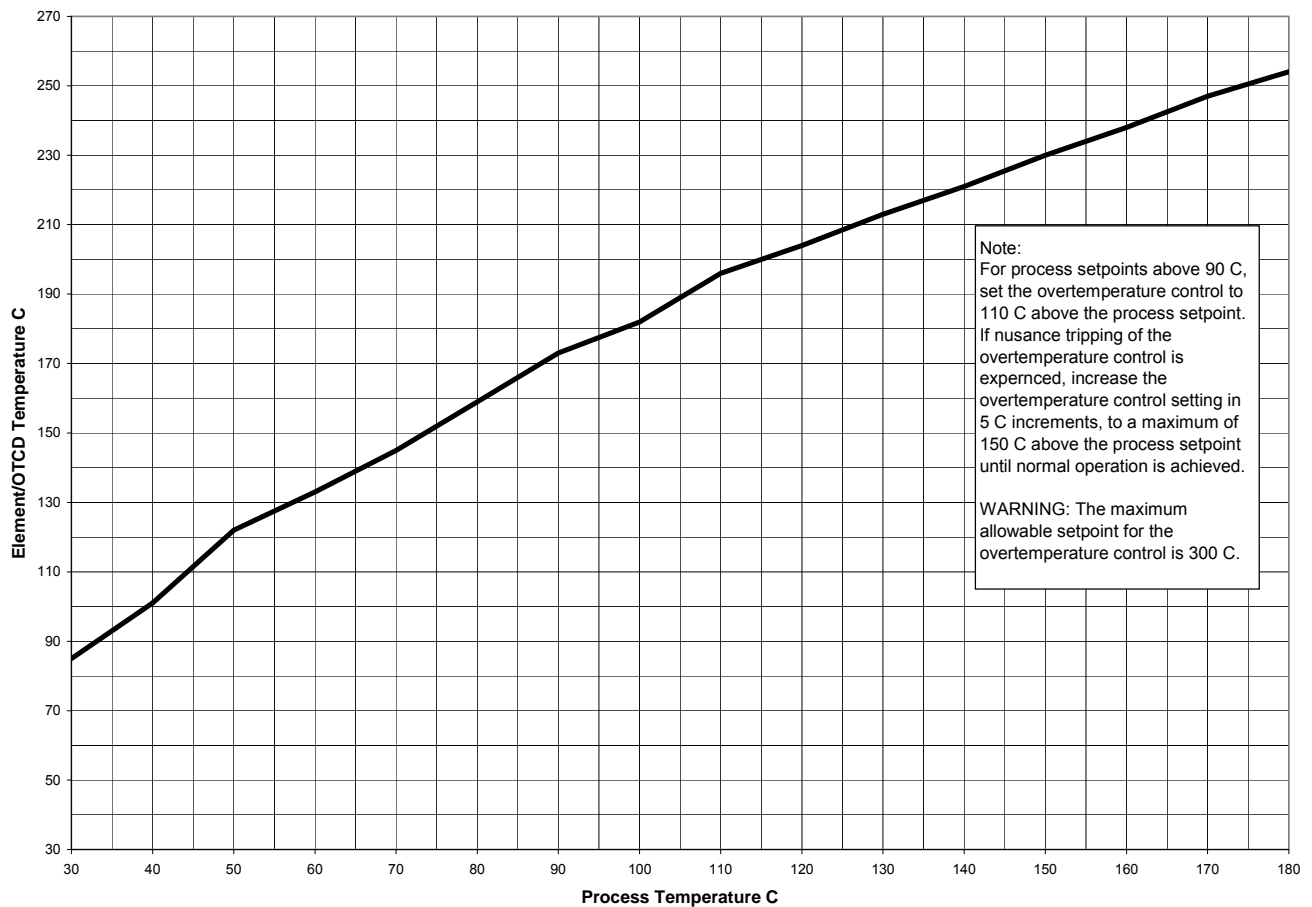

Chart 2 : Element Over-temperature Control Setting Values

OPERATION:

Start Up Procedure:



During operation, the surface temperature of the heater may exceed 90°C. Avoid contact with the TIH heater. Serious personal injury may result.

- 1) Start process fluid flow. Allow solution to flow for several minutes to remove any air from the heating chamber.
- 2) Turn on the main power to the system.
- 3) Turn on the control module.
- 4) Verify proper reading of the process temperature.
- 5) Engage the control system's safety relay, if applicable.
- 6) Turn on the heater.

Cleaning:

This Series TIH in-line heater was cleaned before shipment. However, cleaning is typically required to remove any contaminants remaining after installation. The times required for cleaning of the system are dependent on DI water quality, flow rates, and installation techniques, and will vary. Additional steps may be indicated for some applications.

- 1) Operate the Series TIH in-line heater at ambient temperature for several hours, overnight if possible, at a minimum flow rate of 1 lpm (0.25 gpm).
- 2) Operate the Series TIH in-line heater for several hours, overnight if possible, at the maximum DI Water flow rate that will allow an exit temperature at or above 70°C to be maintained.

Note: Components of the In-line heater are constructed of PFA encapsulated Viton and PFA encapsulated Red Silicon. Verify chemical compatibility before sanitizing the unit.

OPERATION (CONTINUED):

Shut-Down Procedure:



The heater chamber may contain process solution or residue. This material should be handled with the same care and precautions as any process solution.

- 1) Turn off electrical power to the heater. Allow liquid flow to continue through the unit.
- 2) Allow heater to cool. The In-line heater may be damaged if the heater is allowed to operate in air or if residual heat is not allowed to dissipate before draining. Before the chamber is drained, the outlet temperature must be allowed to cool to within 1°C of the inlet temperature. Then, wait an additional 10 minutes.
- 3) Turn OFF process fluid flow through the Heater.
- 4) Turn OFF process controller.
- 5) Turn OFF Main Electrical Power.
- 6) For extended shut down periods, drain the system.

Draining Procedure (with drain fitting):

Open the drain valve and allow any solution in the chamber to drain from the unit. For proper draining, ensure that the outlet plumbing is NOT obstructed to allow proper “venting” to the chamber.

OPERATION (CONTINUED):

Draining Procedure (without drain fitting):

A unit without optional fluid drain must be purged with low pressure inert gas, such as Nitrogen (N₂) or Clean Dry Air (CDA). The purge gas supply must be at a pressure of no greater than 10 psig (69 kPa) regulated to a flow rate of 5 scfh (140 l/h).

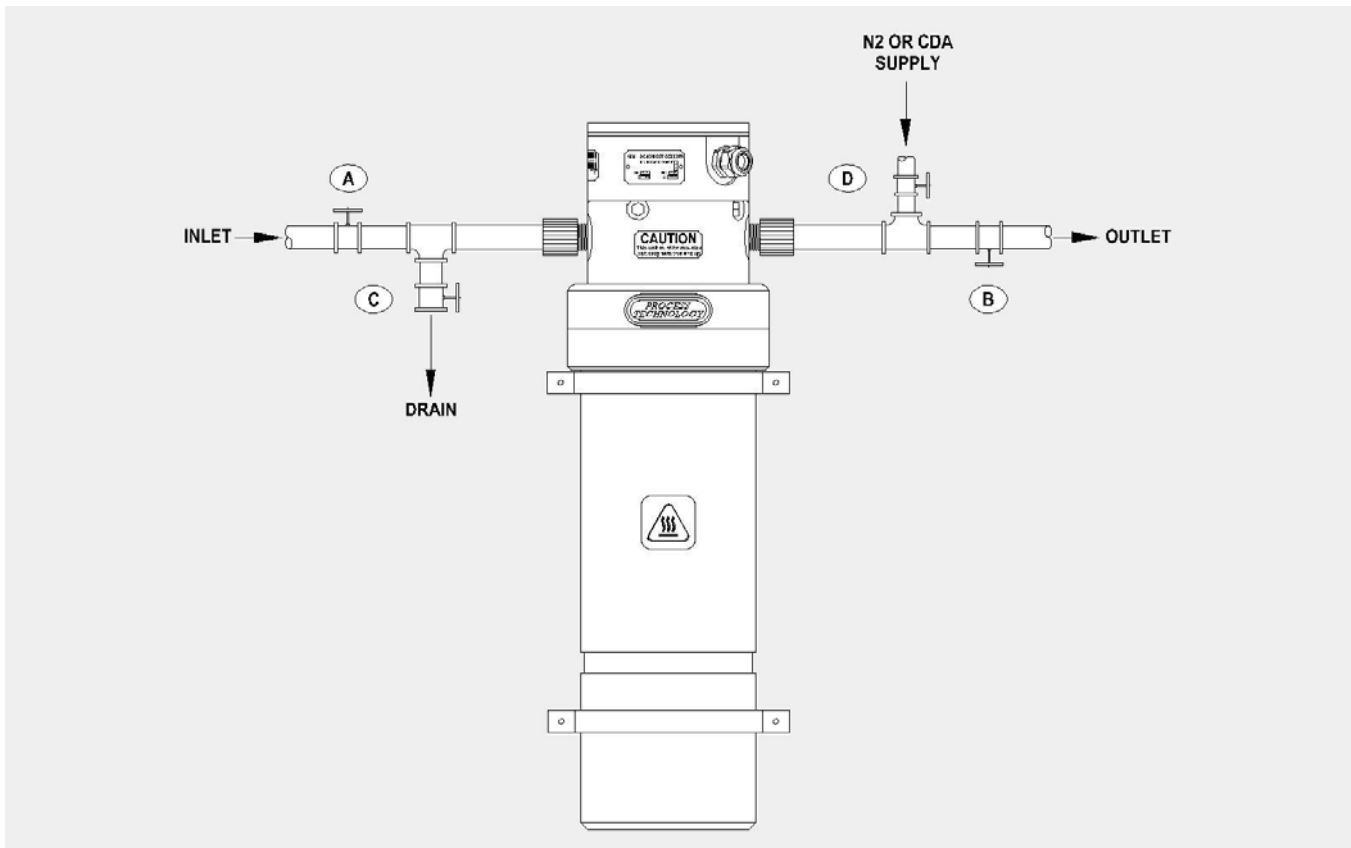

Figure 10: Alternate method for draining the TIH without a built in drain fitting

Maintenance:

Preventative Maintenance of the In-line Heater Chamber:

The Process Technology TIH in-line heater requires minimal preventative maintenance. The process inlet/outlet fittings should be checked for leaks every Six Months.

Service:

If your TIH in-line chemical heater fails to perform properly, follow the outlined steps for resolution.

- 1) Verify the plumbing connections and program parameters.
- 2) Contact the PROCESS TECHNOLOGY Technical Service Group. When placing this call, please have available the model number and serial number of the unit (located on the system tag), information about the application of the equipment, and information regarding the process chemical.
- 3) The Service Technician will evaluate the situation and determine an appropriate course of action.
- 4) If the Technician determines that the unit should be returned to the factory for evaluation, a Returned Materials Authorization (RMA) Number will be issued. A return will not be accepted without prior authorization.

To protect the safety of PROCESS TECHNOLOGY's workers and any others that may come in contact with the TIH in the course of transport, evaluation and repair, the following procedure must be followed for returning the equipment to the factory:

- 1) Rinse the equipment until it is free of any chemical residuals. This is required for safe transport and handling of the equipment.
- 2) Wrap the unit in plastic and secure. Make sure that it does not leak. (PROCESS TECHNOLOGY is not responsible for damage caused by leakage during shipping.)
- 3) Carefully package the unit for shipment.
- 4) Indicate the type of chemical that was in use at the time of failure with the appropriate MSDS information. Include this information on the packing slip or place the information on the outside of the box. PROCESS TECHNOLOGY will not risk exposure of its personnel to unknown chemicals. A return will not be evaluated until chemical information is received.

Note: Because of the configuration of the heating coils within the unit, it is possible that process fluid residues may remain even after thorough rinsing. Chemical information must be included even when a unit is believed to be clean so that PROCESS TECHNOLOGY may protect its workers from exposure to these residues.

- 5) Clearly mark the outside of the box with the RMA number.
- 6) Ship the component prepaid to PROCESS TECHNOLOGY.

WARRANTY:

All PROCESS TECHNOLOGY equipment, heaters and controls have been carefully inspected before shipping and are warranted to be free from defects in workmanship and materials for a period of one year from date of purchase on a pro-rated basis. At its option, PROCESS TECHNOLOGY will repair or replace any defects that are exhibited under proper and normal use. PROCESS TECHNOLOGY disclaims any responsibility for misuse, misapplication, negligence or improper installation of equipment, tempering or other operating conditions that are beyond its control (such as excessively high or low purge gas supply pressure). PROCESS TECHNOLOGY makes no warranty or representation regarding the fitness for use or the application of its products by the customer.

All products and components not manufactured by PROCESS TECHNOLOGY will carry the original manufacturer's warranty, copies of which are available upon request. PROCESS TECHNOLOGY makes no warranty or representation, expressed or implied, with respect to the products not manufactured by PROCESS TECHNOLOGY.

Products must be installed and maintained in accordance with PROCESS TECHNOLOGY instructions.

PROCESS TECHNOLOGY is not liable for labor costs incurred in removal, reinstallation, or unauthorized repair of the product or for damage of any type including incidental or consequential damage.

PROCESS TECHNOLOGY neither assumes nor authorizes any representative of PROCESS TECHNOLOGY or any other person to assume for it any other liabilities in connection with the sale of the products. This warranty may not be verbally changed or modified by any representative of PROCESS TECHNOLOGY.

Shipping Damages:

Claims against freight carriers for damage in transit must be filed by the customer at the time of delivery or as soon as possible.

Returns:

No product shall be returned to PROCESS TECHNOLOGY without first obtaining a return material authorization (RMA) number from a PROCESS TECHNOLOGY representative. All returns must be freight prepaid. Freight collect or shipments without authorization will be refused.

Information:

PROCESS TECHNOLOGY will endeavor to furnish such advice as it may be able to supply with reference to the use by buyer of any material purchased, but PROCESS TECHNOLOGY makes no guarantees and assumes no obligation or liability for advice given verbally or in print or the results obtained. Buyer assumes all risk and liability that may result from the use of any material, whether used by itself or in combination with other products. No suggestion for product use shall be construed as a recommendation for its use in infringement on any existing patent.

Conflict Between Documents:

Acceptance of this offer is expressly conditioned upon agreement to all terms and conditions contained herein. In the event of a conflict between the terms and conditions of purchaser's purchase order, and PROCESS TECHNOLOGY's terms and conditions, proposal or offer, the latter shall govern.

Your Distributor:

80 Metcalfe Street • Buffalo, NY 14206 U.S.A. • US/CN: 800-777-2436 • 716-856-2300 • Fax: 716-856-7115
www.cdibuffalo.com • E-mail: sales@cdibuffalo.com